



LA1266

AM/FM Tuner System Of Electronic Tuning Type

Functions

FM: IF amplifier, quadrature detector, AF preamplifier, signal meter, IF count output, tuning indicator drive output (common with stop signal, muting drive output)

AM: RF amplifier, MIX, OSC (with ALC), IF amplifier, detector, AGC, signal meter, tuning indicator drive output (common with stop signal), IF count output, local OSC buffer.

Features

- Minimum number of external parts required.
- Excellent S/N
- Local OSC with ALC
- Local OSC buffer
- Tuning indicator pin (common with narrow-band stop signal and muting drive output)
- Variable stop sensitivity (variable separately for FM, AM)
- Less tweet interference
- Signal meter pin
- IF count output

Specifications

Maximum Ratings at Ta=25°C

Parameter	Symbol	Conditions	Ratings	Unit
Maximum supply voltage	V _{CC} max	Pins 7,8,20	16	V
Flow-in current	I ₈	Pin 8	20	mA
Flow-out current	I ₂₂	Pin 22	1	mA
	I ₂₄	Pin 24	2	mA
Allowable power dissipation	P _d max	T _a ≤60°C	700	mW
Operating temperature	T _{opr}		-20 to +70	°C
Storage temperature	T _{stg}		-40 to +125	°C

Operating Conditions at Ta=25°C

Parameter	Symbol	Conditions	Ratings	Unit
Recommended supply voltage	V _{CC}		8.5	V
Operating voltage range	V _{CC} op		6 to 14	V

Package Dimensions

unit : mm

3067-DIP24S

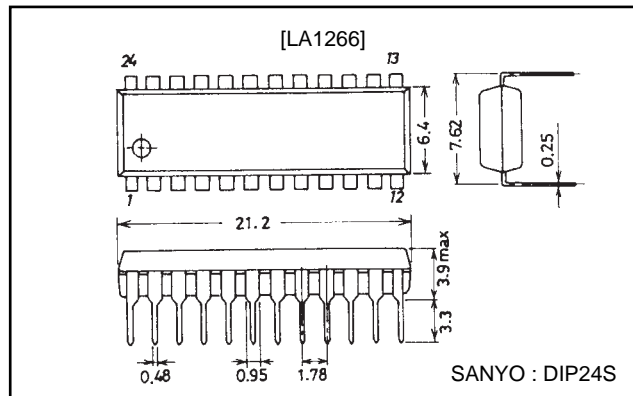

LA1266

Operating Characteristics at $T_a=25^\circ\text{C}$, $V_{CC}=8.5\text{V}$, See Test Circuit.

Parameter	Symbol	Conditions	Ratings			Unit
			min	typ	max	
[AM : $f_c=1\text{MHz}$, $f_m=1\text{kHz}$]						
Quiescent current	I_{CCO}	No input		22	30	mA
Detection output	V_{O1}	$V_{IN}=20\text{dB}\mu$, 30% mod.	30	60	110	mV
	V_{O2}	$V_{IN}=80\text{dB}\mu$, 30% mod.	90	150	210	mV
Signal to noise ratio	S/N1	$V_{IN}=20\text{dB}\mu$	15	19		dB
	S/N2	$V_{IN}=80\text{dB}\mu$	49	54		dB
Total harmonic distortion	THD1	$V_{IN}=80\text{dB}\mu$, 30% mod.		0.3	1.0	%
	THD2	$V_{IN}=107\text{dB}\mu$, 30% mod.		0.3	1.0	%
Signal meter output	V_{SM1}	No input	0	0	0.2	V
	V_{SM2}	$V_{IN}=80\text{dB}\mu$	1.8	2.8	3.5	V
LED drive sensitivity	LED-ON	$I_{LED}=1\text{mA}$	13	23	33	dBm
Local OSC buffer output	V_{OSC}	$f_{osc}=1.45\text{MHz}$	220	280	340	mV
IF buffer output	V_{IF}	$V_{IN}=20\text{dB}\mu$	120	180	250	mV
[FM : $f_c=10.7\text{MHz}$, $f_m=1\text{kHz}$]						
Quiescent current	I_{CCO}	No input		29	40	mA
Input limiting sensitivity	-3dBLS.	3dB down, 100% mod.		31	37	dB μ
Demodulation output	V_O	$V_{IN}=100\text{dB}\mu$, 100% mod.	270	390	540	mV
S/N ratio	S/N	$V_{IN}=100\text{dB}\mu$	78	84		dB
Total harmonic distortion	THD	$V_{IN}=100\text{dB}\mu$, 100% mod.		0.03	0.3	%
Signal meter output	V_{SM1}	No input	0	0	0.2	V
	V_{SM2}	$V_{IN}=100\text{dB}\mu$	1.7	2.3	3.1	V
LED drive sensitivity	LED-ON	$I_{LED}=1\text{mA}$	46	61	76	dB μ
LED drive bandwidth	LED-BW	$V_{IN}=100\text{dB}\mu$, $I_{LED}=1\text{mA}$	70	105	140	kHz
AM rejection ratio	AMR	$V_{IN}=100\text{dB}\mu$, 100% mod. AM-1kHz, 30% mod.	45	58		dB
IF buffer output	V_{IF}	$V_{IN}=50\text{dB}\mu$	110	160	230	mV

Equivalent Circuit Block Diagram

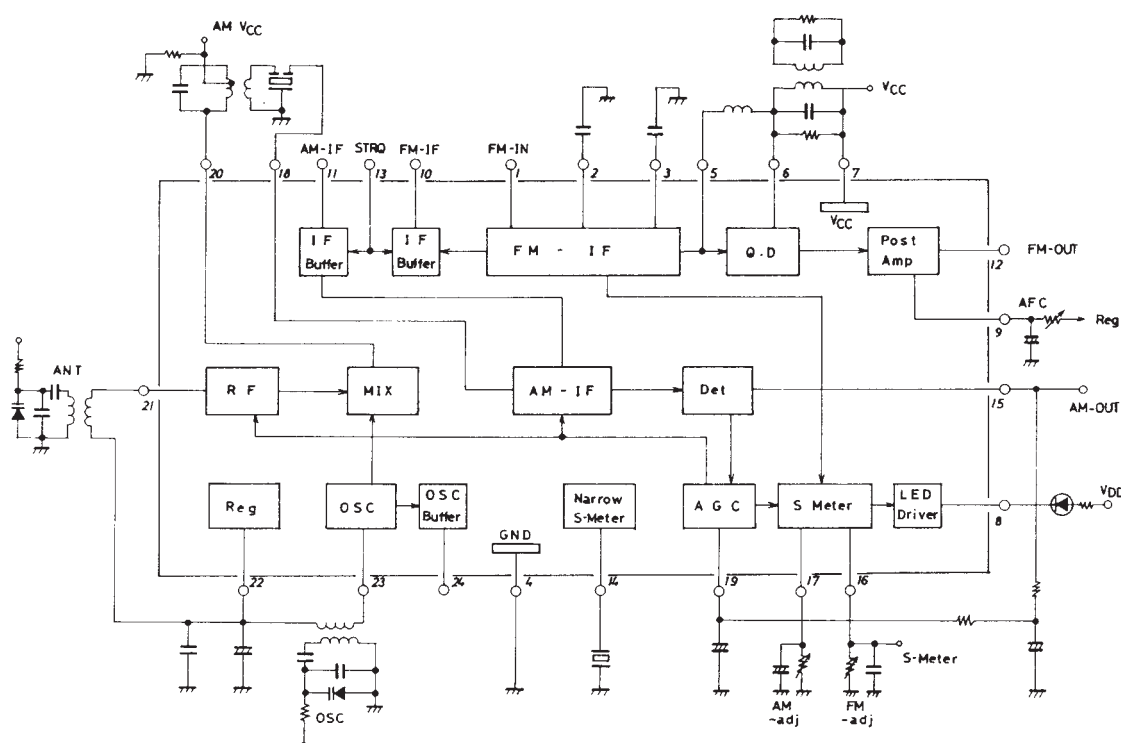

How to use LA1266

1. LED driver, muting drive output, stop signal(SD).

- For LED drive, muting drive output, stop signal, the output at pin 8 is used.
- Voltage on pin 8, when tuned, turns from "H" to "L" . (Active-low)
- Signal bandwidth at pin 8
 - For AM, the bandwidth depends on the C.F(BFU450CN) at pin 14.
If a capacitor is connected in place of the C.F, the bandwidth will get wider.
 - For FM, the bandwidth depends on the resistance across pins 9 and 22.
If the resistance is increased, the bandwidth will get narrower.
R=15kΩ makes the bandwidth approximately 110kHz.

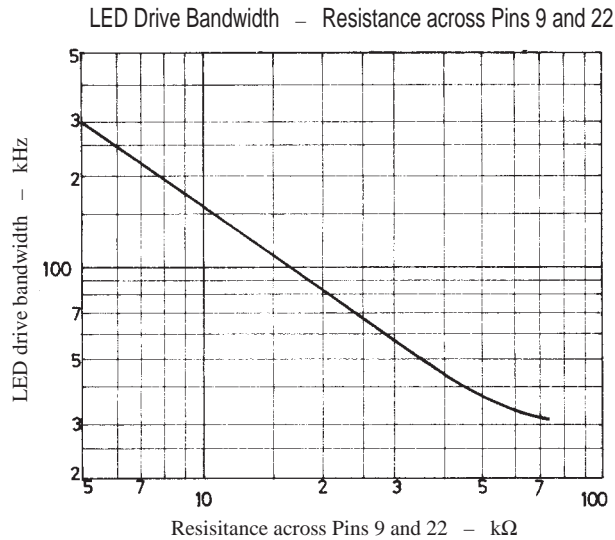

- Sensitivity adjustment of LED, muting, stop signal
 - For FM, the semifixed variable resistor across pin 16 and GND is used.
 - For AM, the semifixed variable resistor across pin 17 and GND is used.
- The relation (for AM,FM) between signal meter voltage and input voltage with the resistance of the semifixed variable resistor as a parameter is shown below.

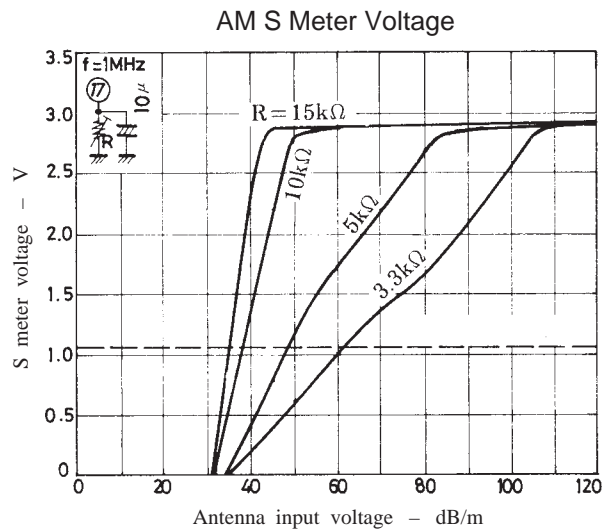
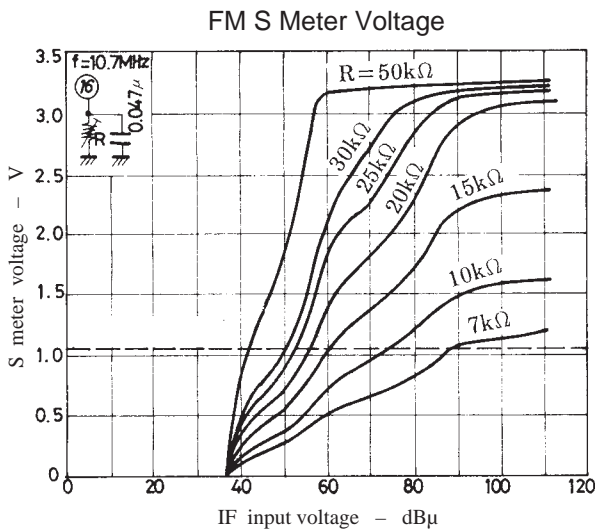

Unit (capacitance : F)

2. AM/FM changeover

- AM/FM changeover is made using pin 20 as shown right.
- However, the voltage on pin 20 relative to V_{CC} (pin 7) must be within the range of +0.1V to -0.8V. If not within this range, distortion and selectivity will get worse. A resistance of 68k Ω at the IFT cold terminal, which is used to prevent the changeover circuit from malfunctioning, must be connected.

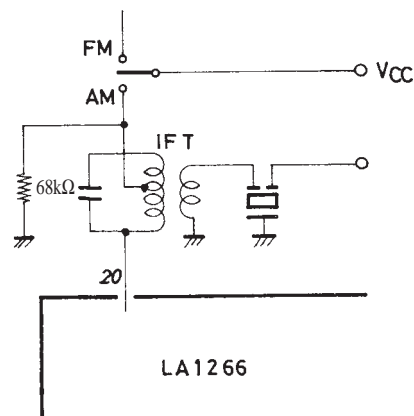

3. Local OSC buffer output

- When local OSC buffer output waveform is saw-toothed at the SW mode, connect a resistance of 1.2k Ω or thereabouts across pin 24 and GND.

4. Capacitance across pin 9 and GND

A large capacitance across pin 9 and GND may cause a misstop at an adjacent channel when the channel select speed is made faster at the automatic channel select mode. In this case, decrease the capacitance across pin 9 and GND.

However, if too decreased, the LED will flutter at low modulation frequencies at the time of detuning.

Therefore, it is recommended to fix the capacitance across pin 9 and GND to be 3.3 μ F to 10 μ F.

The relation between modulation frequency and demodulation output voltage on pin 9 with the capacitance across pin 9 and GND as a parameter is shown right.

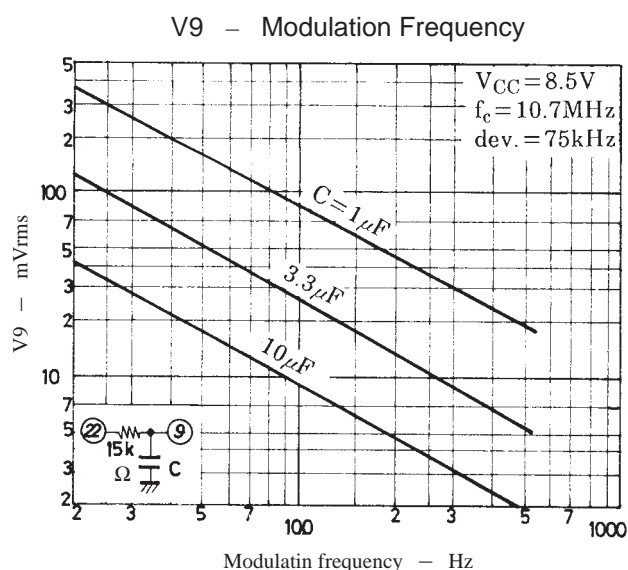

- 5. If the coupling coefficient of the local OSC coil is small and an antiresonance point of approximately 100MHz is present or the stray capacitance across pin 24 and pin 23 is large, a parasitic oscillation of approximately 100MHz may occur in the buffer output (pin 24). In this case, connect a capacitance of approximately 30pF across pin 24 and GND.

6. AM OSC coil

Generally speaking, the following should be noted. Avoid winding with loose coupling between primary side and secondary side (especially SW1, SW2). To be concrete, the pot core type is better than the screw type which is loose in coupling. This prevents the local OSC frequency from turning third resonance frequency related to the coupling coefficient.

7. Resistance across pin 8 and V_{DD}

If pin 8 is used for stop signal (SD) only, without using LED, it is recommended to fix resistance R_L across pin 8 and V_{DD} to be 51k Ω to 100k Ω .

- 8. To prevent whistle from worsening, make the pattern of AM output pin 15 as short as possible.

9. AM, FM IF buffer output

Application of a voltage to pin 13 (STRQ) causes AM IF(455kHz) signal (at AM mode) and FM IF(10.7MHz) signal (at FM mode) to be delivered at pin 11 and pin 10, respectively. It is recommended that the voltage to be applied to

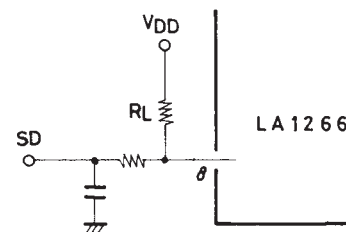

AM S Meter Current Characteristic

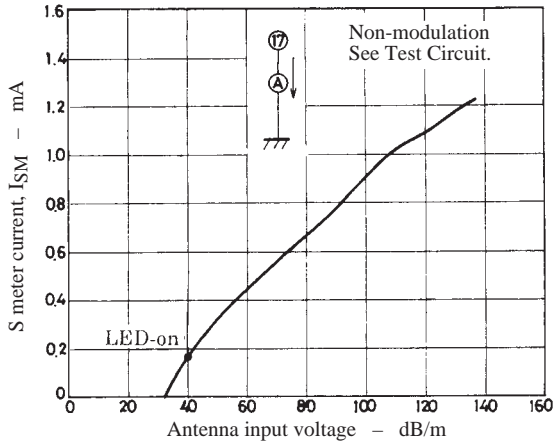

AM S Meter Voltage Characteristic

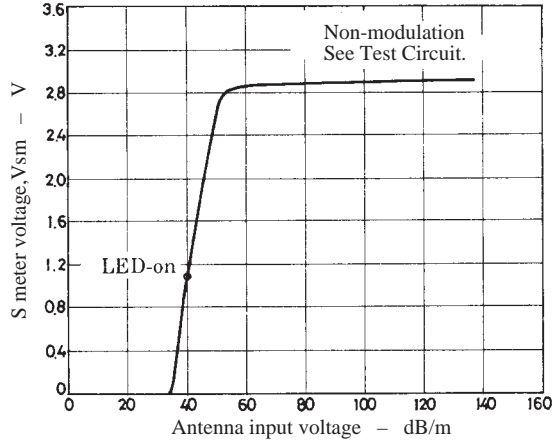

Fidelity Characteristic

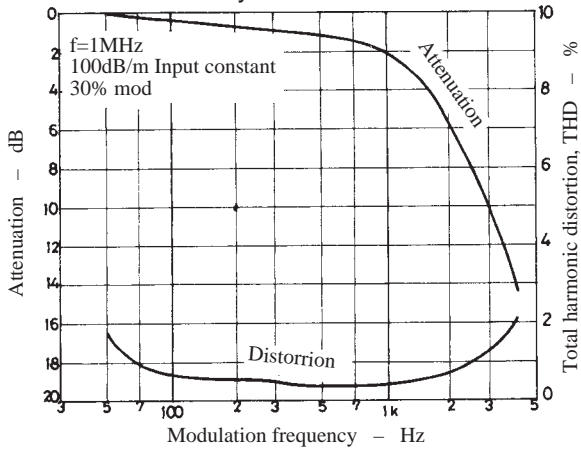

Selectivity Characteristic

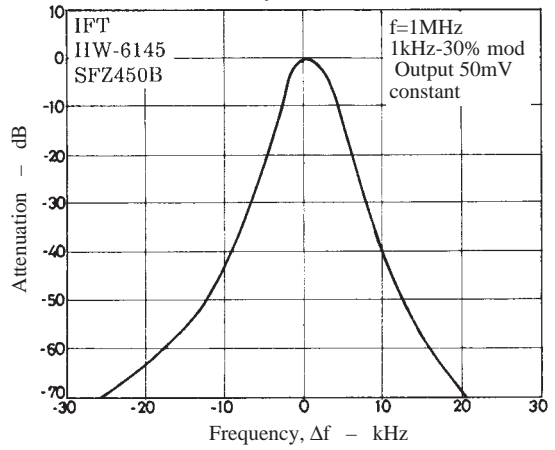

AM V_{CC} Characteristic

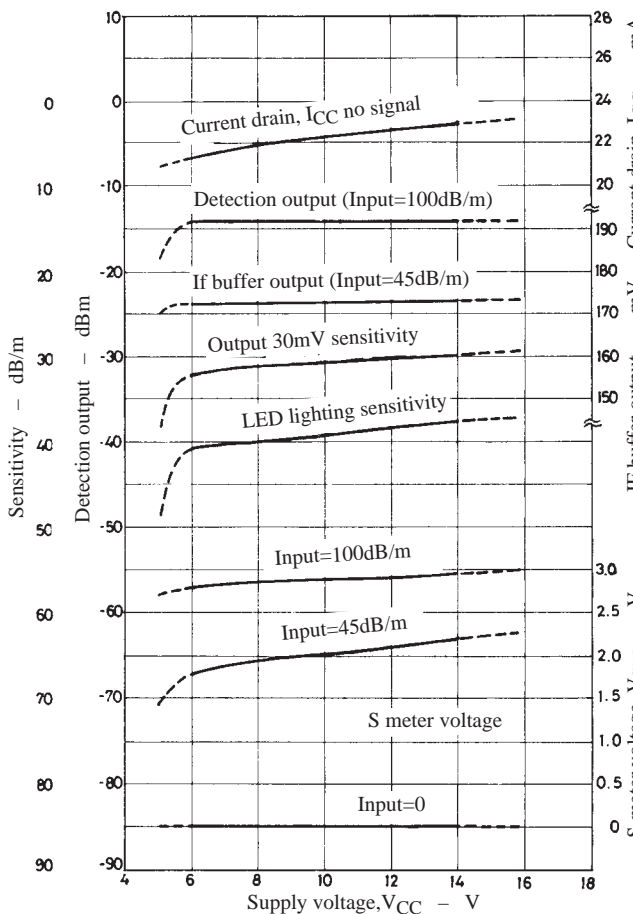

AM Temperature Characteristic (1)

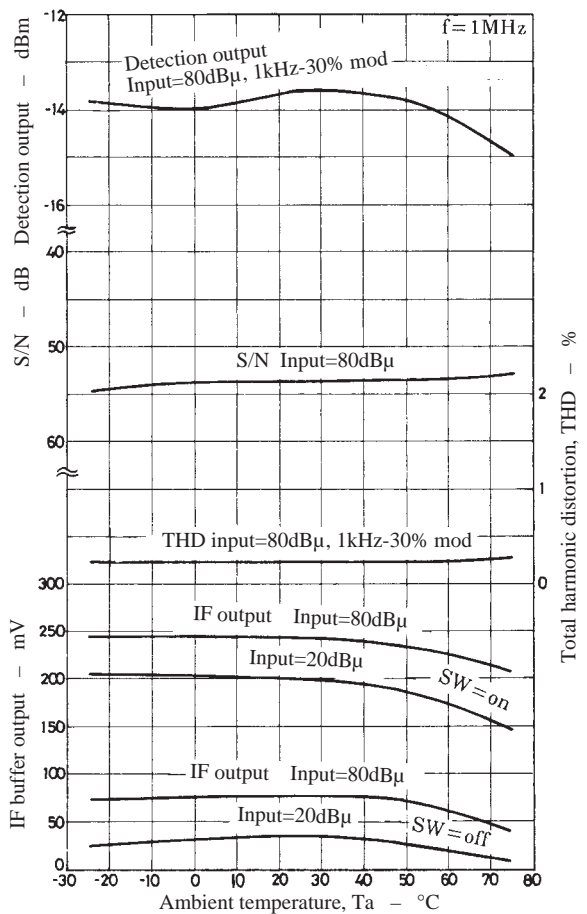

AM Temperature Characteristic(2)

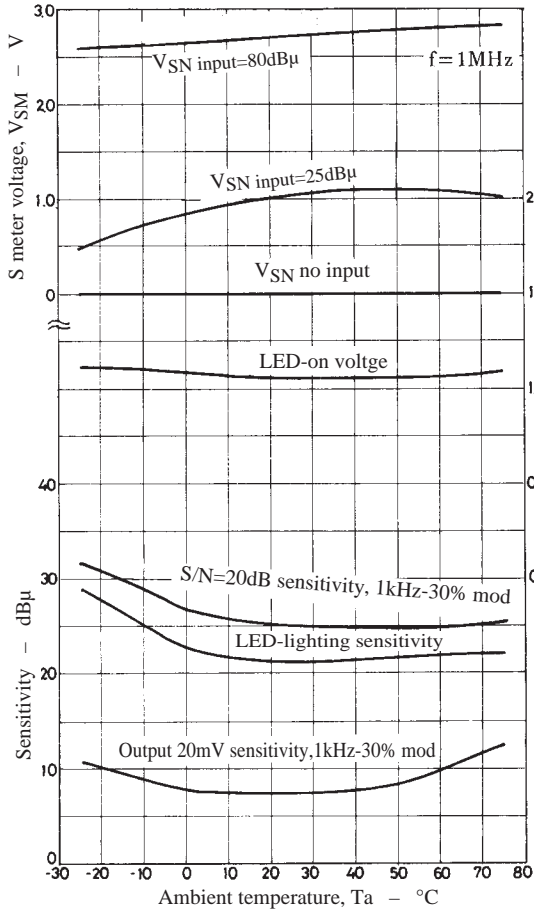

FM Input/Output Characteristic

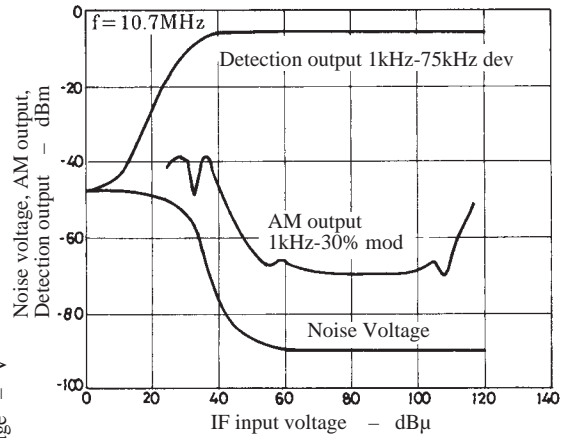

Distortion Characteristic

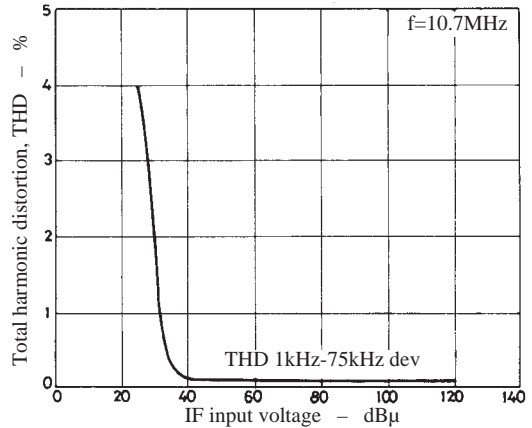

FM S Meter Characteristic

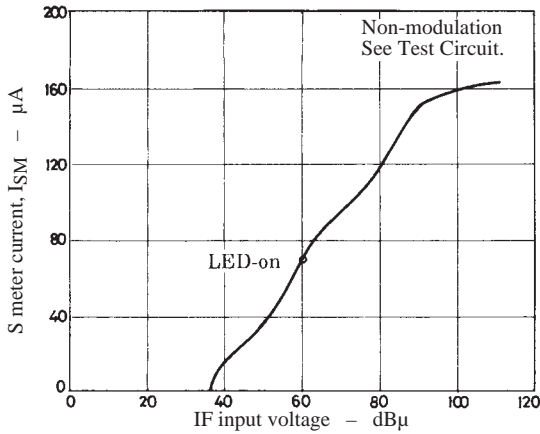

FM S Meter Voltage Characteristic

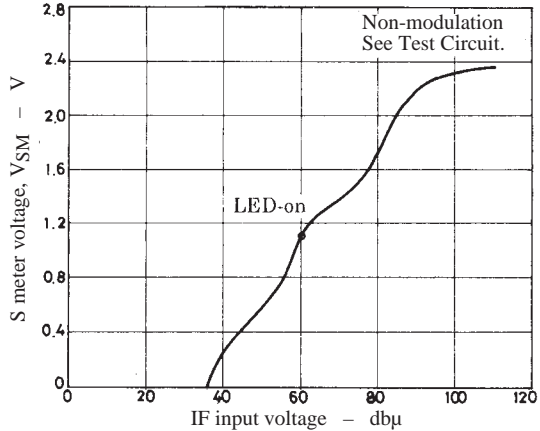

FM V_{CC} Characteristic

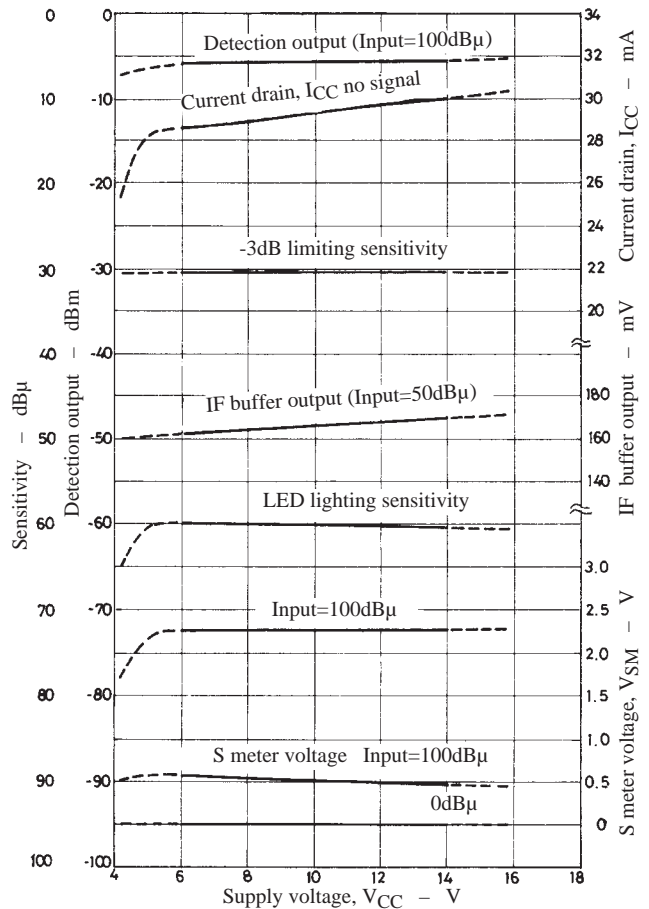

FM Temperature Characteristic(1)

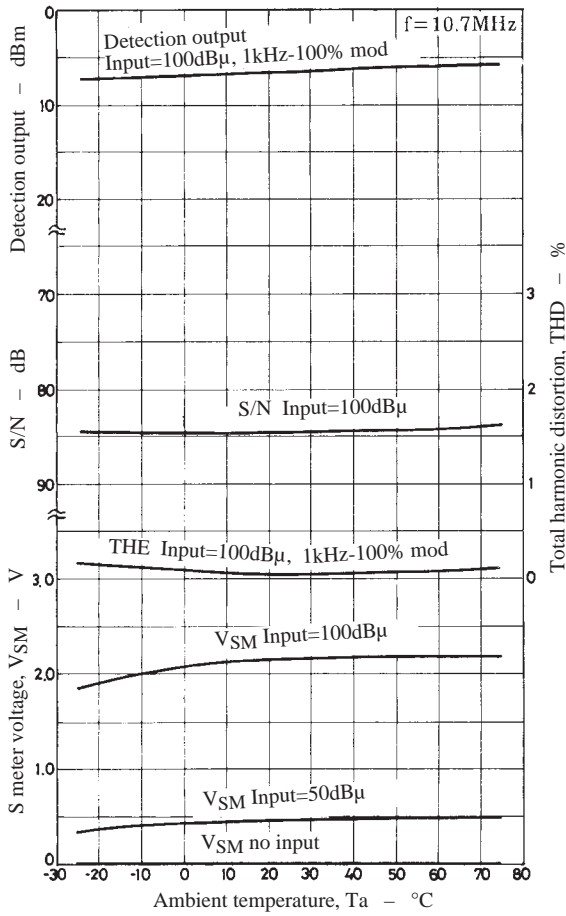

FM Temperature Characteristic(1)

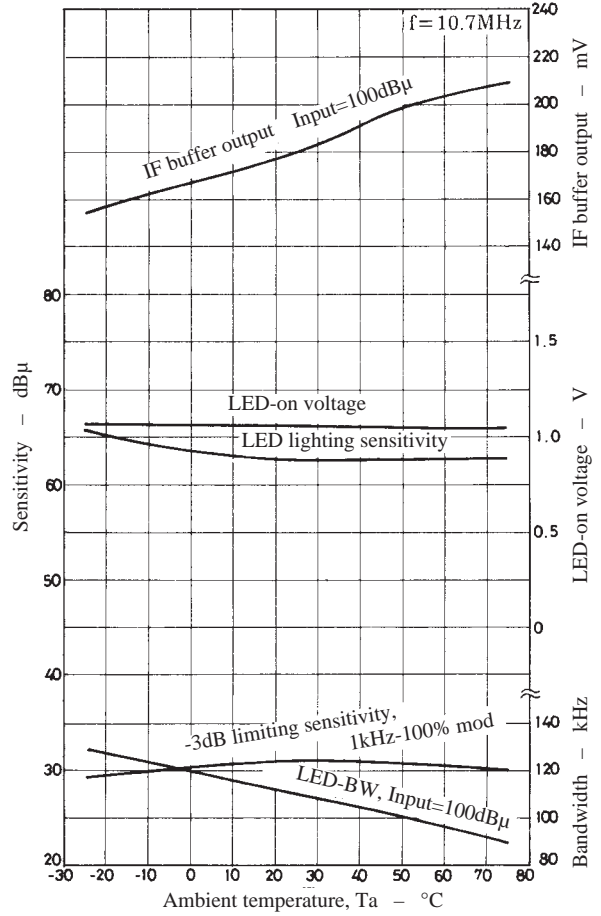

AM Receiving Characteristic

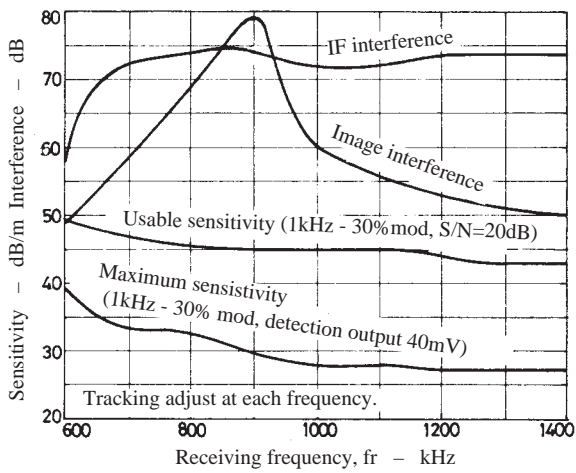

Coil Specifications

MW antenna
 Bar antenna (for PVC22KTL)
 •TN-10896 (Mitsumi)

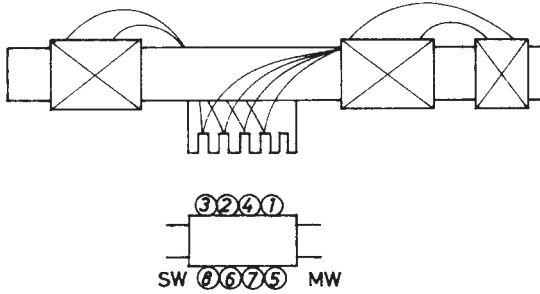

①-② 22T + 49T, ③-④ 10T
 Tight solenoid direct winding
 ⑤-⑥ 17T 0.5φ space winding
 ⑦-⑧ tight solenoid winding
 ①-② $L = 260\mu\text{H}$, $Q_0 = 330 (\geq 200)$
 ⑤-⑥ $L = 15\mu\text{H}$, $Q_0 = 250 (\geq 150)$

Loop antenna (for SVC321)
 • LA300 (Korin Giken)
 Loop antenna, matching coil
 • KL-412

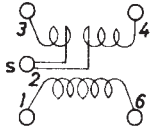

①-⑥ 15.5T, ③-② 7T,
 ②-④ 58T
 $Q_0 = 200 \pm 20\%$
 $L = 248\mu\text{H} \pm 10\%$

YT-30150 (Mitsumi)

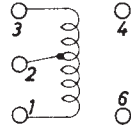

③-② 32T, ②-① 32T
 0.07mm 2VEW
 $Q_0 = 140$, $L = 140\mu\text{H}$

• KO-387 (Korin Giken)
 For SVC321

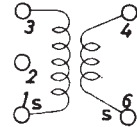

①-③ 48T, ④-⑥ 20T
 $Q_0 = 150 \pm 20\%$

AM IFT coil
 Matching coil for SFZ450B
 (2-element type)

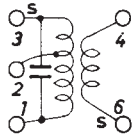

• HW-6145 (Mitsumi)
 ③-② 67T, ⑥-④ 10T
 ②-① 85T
 $Q_0 = 70 \pm 20\%$, $f = 450\text{kHz}$
 Internal 180pF

FM double tuning detection coil
 HW-6146

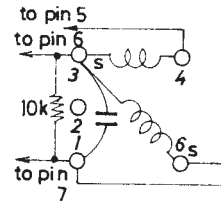

• HW-6146 (Mitsumi)
 ③-④ 86.5T
 ③-⑥ 13.5T
 $Q_0 = 50 \pm 20\%$
 Internal 100pF±10%

HW-40131

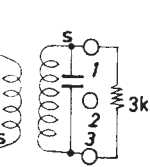

Unit (resistance : Ω)
 • HW-40131 (Mitsumi)
 ④-⑥ 1T
 ①-③ 19T
 $Q_0 = 35 \pm 20\%$
 Internal 100pF±10%

LA1177+LA1266 Overall Characteristic

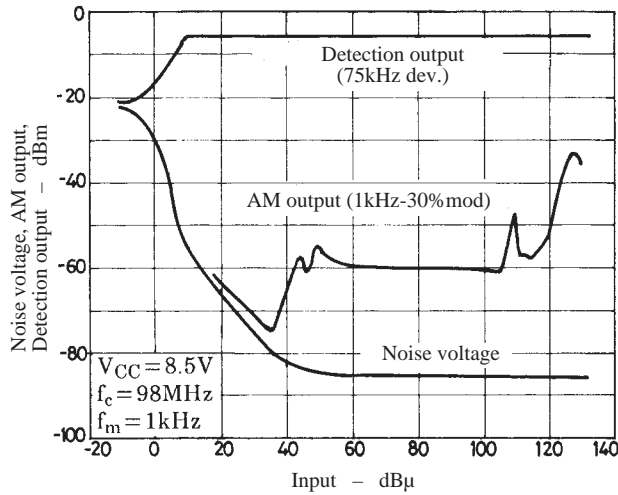

LA1177+LA1266 Overall Characteristic

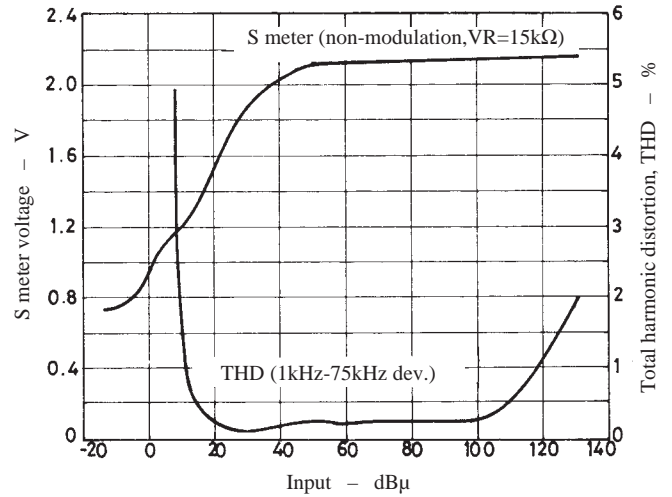

■ No products described or contained herein are intended for use in surgical implants, life-support systems, aerospace equipment, nuclear power control systems, vehicles, disaster/crime-prevention equipment and the like, the failure of which may directly or indirectly cause injury, death or property loss.

■ Anyone purchasing any products described or contained herein for an above-mentioned use shall:

- ① Accept full responsibility and indemnify and defend SANYO ELECTRIC CO., LTD., its affiliates, subsidiaries and distributors and all their officers and employees, jointly and severally, against any and all claims and litigation and all damages, cost and expenses associated with such use;
- ② Not impose any responsibility for any fault or negligence which may be cited in any such claim or litigation on SANYO ELECTRIC CO., LTD., its affiliates, subsidiaries and distributors or any of their officers and employees jointly or severally.

■ Information (including circuit diagrams and circuit parameters) herein is for example only; it is not guaranteed for volume production. SANYO believes information herein is accurate and reliable, but no guarantees are made or implied regarding its use or any infringements of intellectual property rights or other rights of third parties.

This catalog provides information as of November, 1997. Specifications and information herein are subject to change without notice.